

BRIDGE BASICS 1  
 DEAL: 1  
 DEALER: NORTH

♣ A Q 9  
 ♦ 9 6  
 ♠ 7 6  
 ♥ A K Q J 10 9

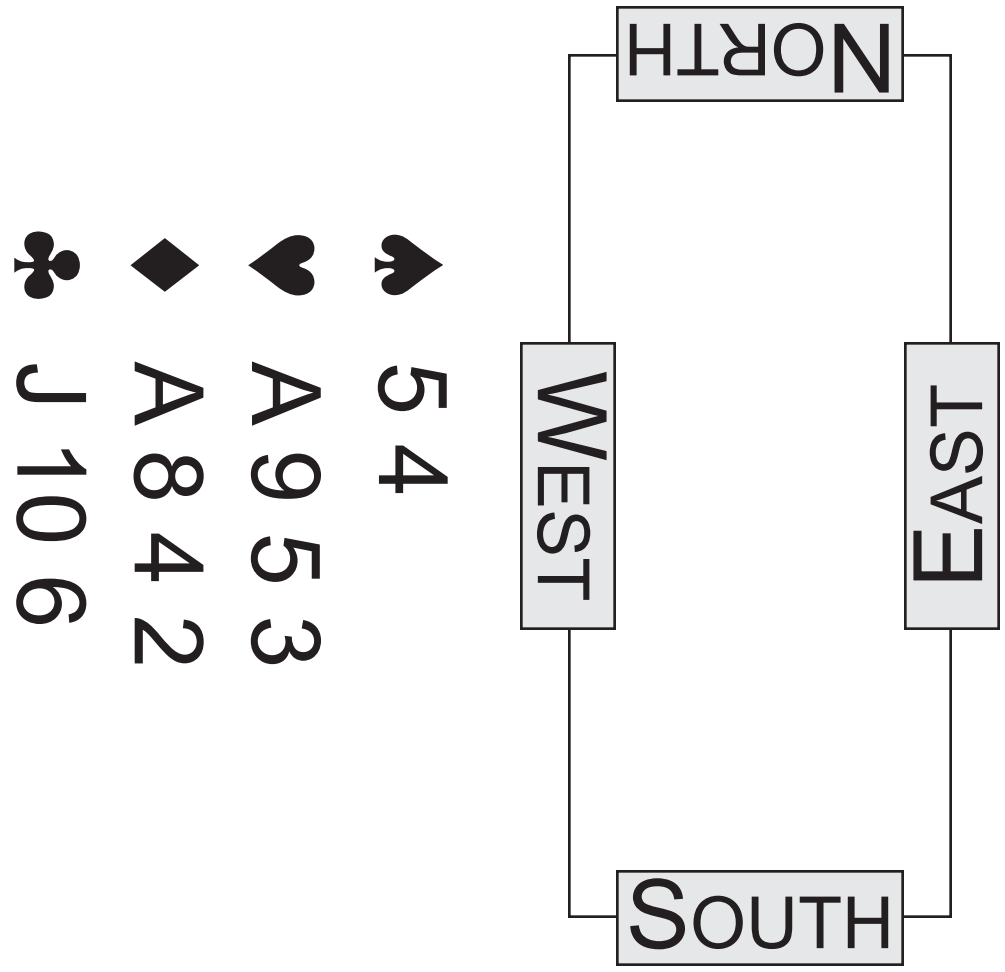

♥ 5 4  
 ♠ A 9 5 3  
 ♦ A 8 4 2  
 ♣ J 10 6

♠ 6 3  
 ♥ K Q J 4  
 ♦ K J 3  
 ♣ 7 5 4 2

♠ 8 7 2  
 ♥ 10 8 2  
 ♦ Q 10 7 5  
 ♣ K 8 3

BRIDGE BASICS 1  
 DEAL: 1  
 DEALER: NORTH

BRIDGE BASICS 1

DEAL: 2

DEALER: EAST

♣ 10 8 6  
 ♦ 9 6  
 ♥ K J 3 2  
 ♠ K J 6 2

NORTH

WEST

EAST

SOUTH

♠ Q 10 4  
 ♥ Q 9 4  
 ♦ 8 0 1 J Q  
 ♣ 4 7 J

♠ A 7 3  
 ♥ A 9 8  
 ♦ 7 5 4 2  
 ♣ A K Q

BRIDGE BASICS 1  
 DEAL: 2  
 DEALER: EAST

♠ 9 8 5  
 ♥ 10 7 5  
 ♦ A K 3  
 ♣ 9 5 3 2

BRIDGE BASICS 1  
 DEAL: 3  
 DEALER: SOUTH

♣ J 6 4 2  
 ♦ Q 9 6  
 ♥ K J 8 3  
 ♠ 7 2

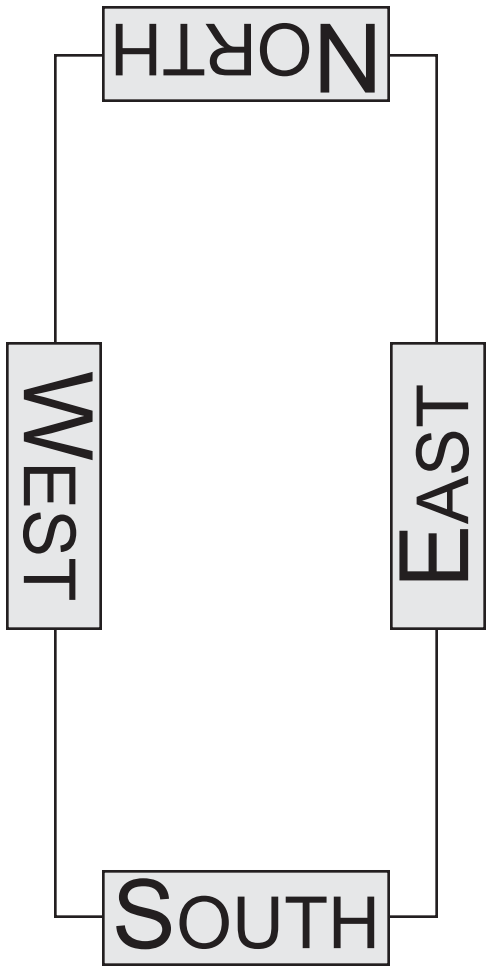

♠ K Q J 10 6  
 ♥ 7 5  
 ♦ 8 4 3  
 ♣ A Q 5

♠ A 9 5 3  
 ♥ 10 6  
 ♦ J 10 5 2  
 ♣ K 9 7

♠ 8 4  
 ♥ A Q 9 4 2  
 ♦ A K 7  
 ♣ 10 8 3

BRIDGE BASICS 1  
 DEAL: 3  
 DEALER: SOUTH

BRIDGE BASICS 1  
 DEAL: 4  
 DEALER: WEST

♣ 9 7 3  
 ♦ 8 5 3  
 ♠ J 4  
 ♥ A K 7 6 3

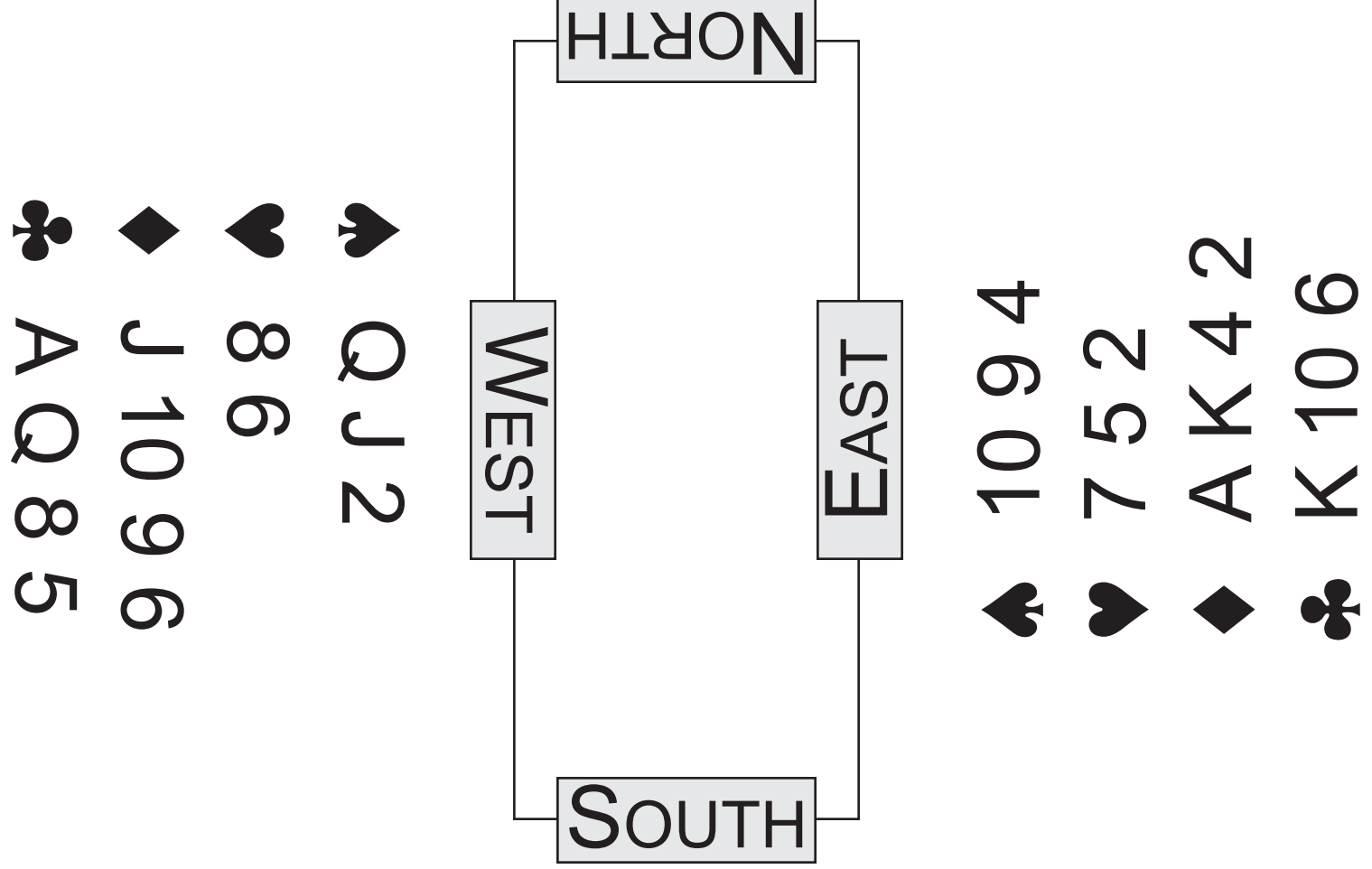

BRIDGE BASICS 1  
 DEAL: 4  
 DEALER: WEST

BRIDGE BASICS 1  
 DEAL: 5  
 DEALER: NORTH

♣ 9 8 7 3  
 ♦ K 6  
 ♠ A K 7 3  
 ♥ A J 5

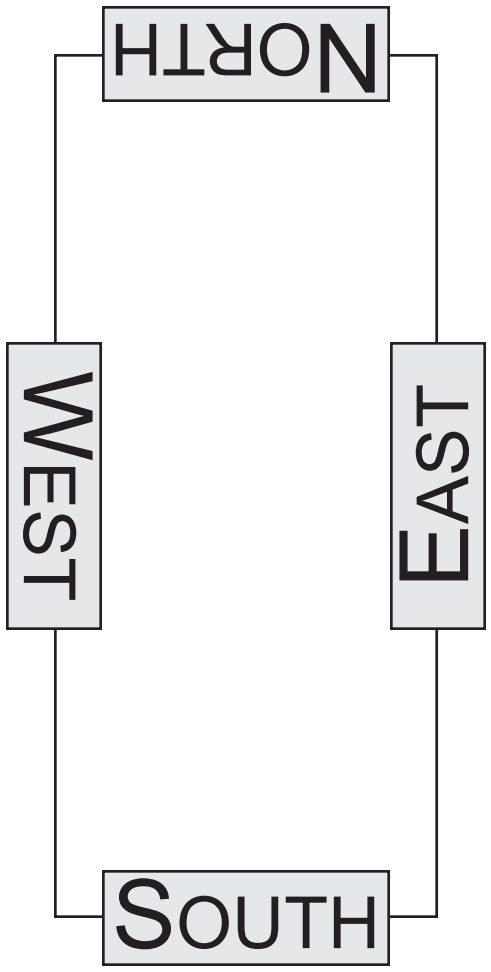

♥ K Q 10 9  
 ♠ Q 8 4 2  
 ♦ 10 8 4 2  
 ♣ 5

♣ A K Q J  
 ♦ 9 7 5  
 ♥ J 10 9  
 ♠ 8 7 4

♠ 6 3 2  
 ♥ 6 5  
 ♦ A Q J 3  
 ♣ 10 9 4 2

BRIDGE BASICS 1  
 DEAL: 5  
 DEALER: NORTH

BRIDGE BASICS 1  
 DEAL: 6  
 DEALER: EAST

♣ K 10 5  
 ♦ J 10 9 7 2  
 ♥ 3  
 ♠ Q 10 6 4

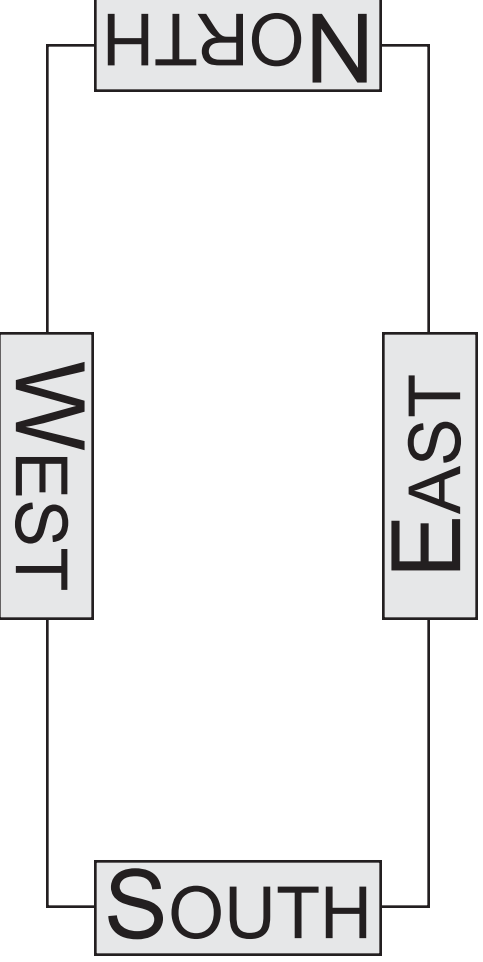

♠ 5 2  
 ♥ K J 10 8 7 5  
 ♦ K Q 4  
 ♣ 7 4

♣ Q 8 6  
 ♦ A 8 3  
 ♥ A Q 2  
 ♠ A 8 7 3

♣ 2 3 6 J A  
 ♦ 9 5  
 ♥ 4 6 6  
 ♠ 9 J K

BRIDGE BASICS 1  
 DEAL: 6  
 DEALER: EAST

BRIDGE BASICS 1  
 DEAL: 7  
 DEALER: SOUTH

♣ K J 6 2  
 ♦ Q 10  
 ♠ 8 4 3 2  
 ♥ A 5 2

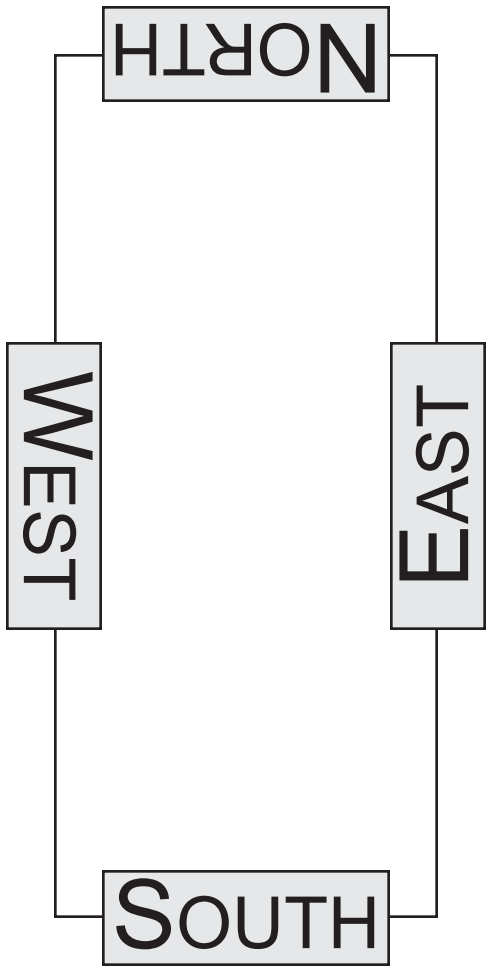

♥ 6 3  
 ♥ A K 7  
 ♦ A K 6 3 2  
 ♣ Q 9 4

7 8 6 0 9 8 7  
 ♠ Q J 10 9 8 7  
 ♥ 9 5  
 ♦ 7 4  
 ♣ 8 5 3

♠ K 4  
 ♥ Q J 10 9  
 ♦ 5 8 6 J  
 ♣ A 10 7

BRIDGE BASICS 1  
 DEAL: 7  
 DEALER: SOUTH

BRIDGE BASICS 1

DEAL: 8

DEALER: WEST

♣ 7 9 6 2  
 ♦ 7 6 4 3  
 ♠ A 6 3  
 ♥ A Q 9

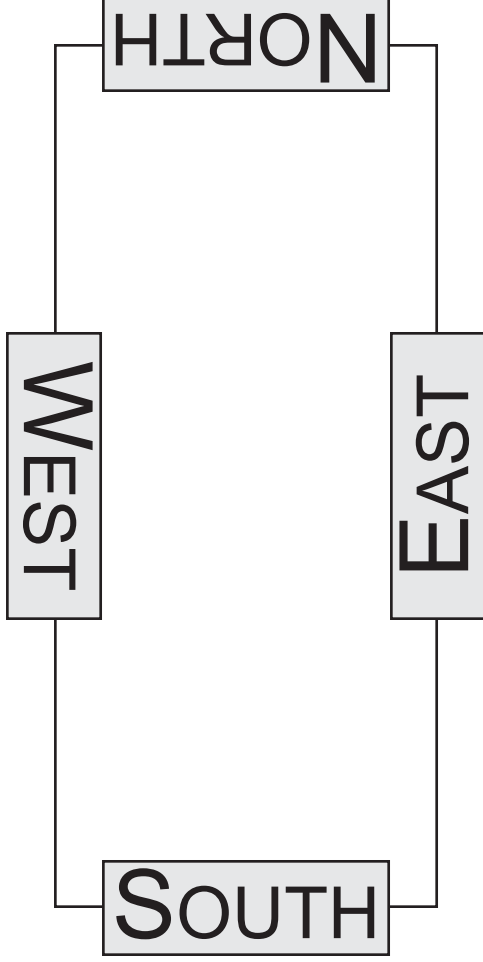

♠ 8 6 3  
 ♥ Q J 10 9  
 ♦ Q 10 8  
 ♣ Q 7 4

♠ J 7 5 2  
 ♥ 8 5 4  
 ♦ J 9  
 ♣ K J 10 3

♠ K 10 4  
 ♥ K 7 2  
 ♦ A K 5 2  
 ♣ A 8 5

BRIDGE BASICS 1  
 DEAL: 8  
 DEALER: WEST

BRIDGE BASICS 1  
 DEAL: 9  
 DEALER: NORTH

♣ 9 6  
 ♦ K 6  
 ♠ A K Q J  
 ♡ 10 8 7 5 2

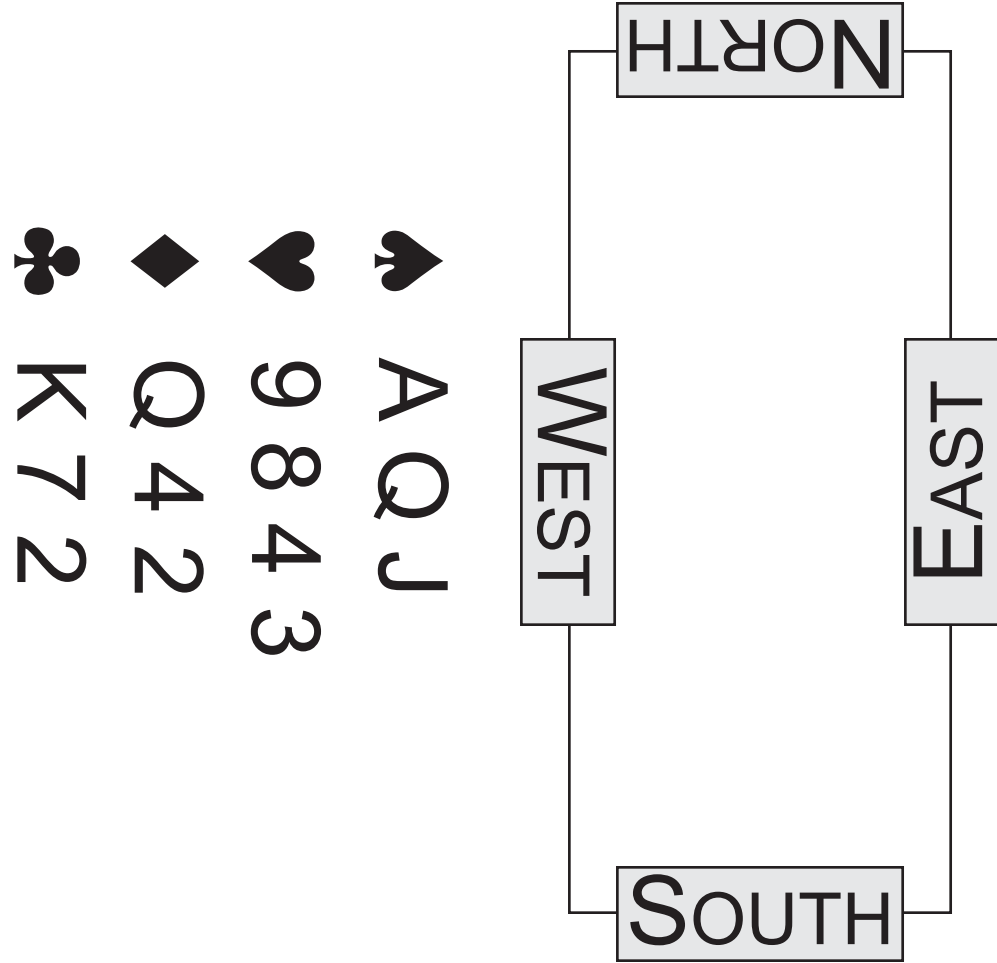

♣ A 8 5 4 3  
 ♦ J 10 9 7 3  
 ♡ 10 6  
 ♠ K

♣ 10 J Q  
 ♦ A 8 5  
 ♡ 7 5 2  
 ♠ 9 6 4 3

BRIDGE BASICS 1  
 DEAL: 9  
 DEALER: NORTH

BRIDGE BASICS 1  
 DEAL: 10  
 DEALER: EAST

♣ K Q 9 7 4 2  
 ♦ 8 7  
 ♠ 9  
 ♡ Q J 8 3

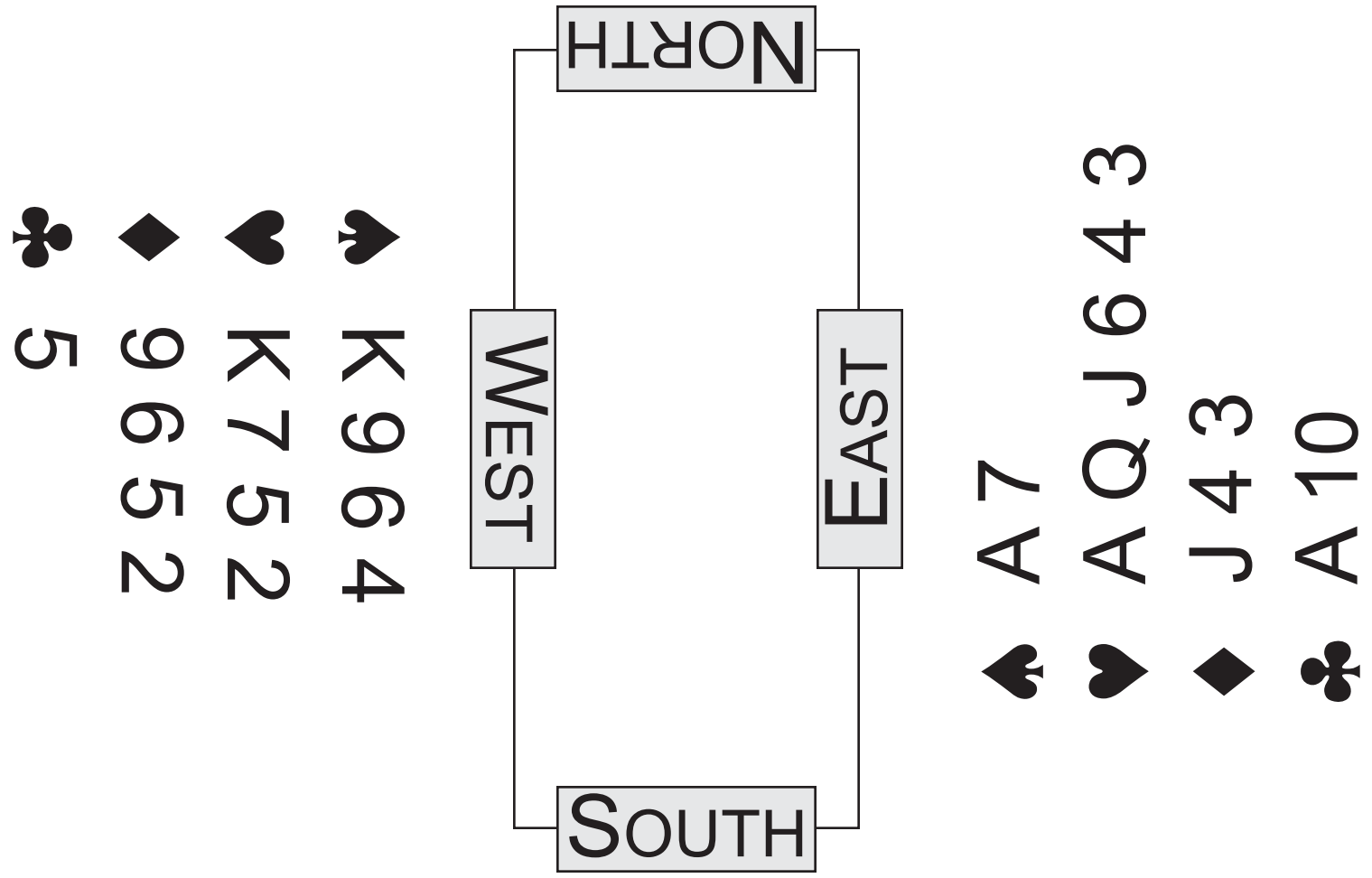

BRIDGE BASICS 1  
 DEAL: 10  
 DEALER: EAST

BRIDGE BASICS 1  
 DEAL: 11  
 DEALER: SOUTH

♣ AK  
 ♦ 96  
 ♠ A10853  
 ♥ AK83

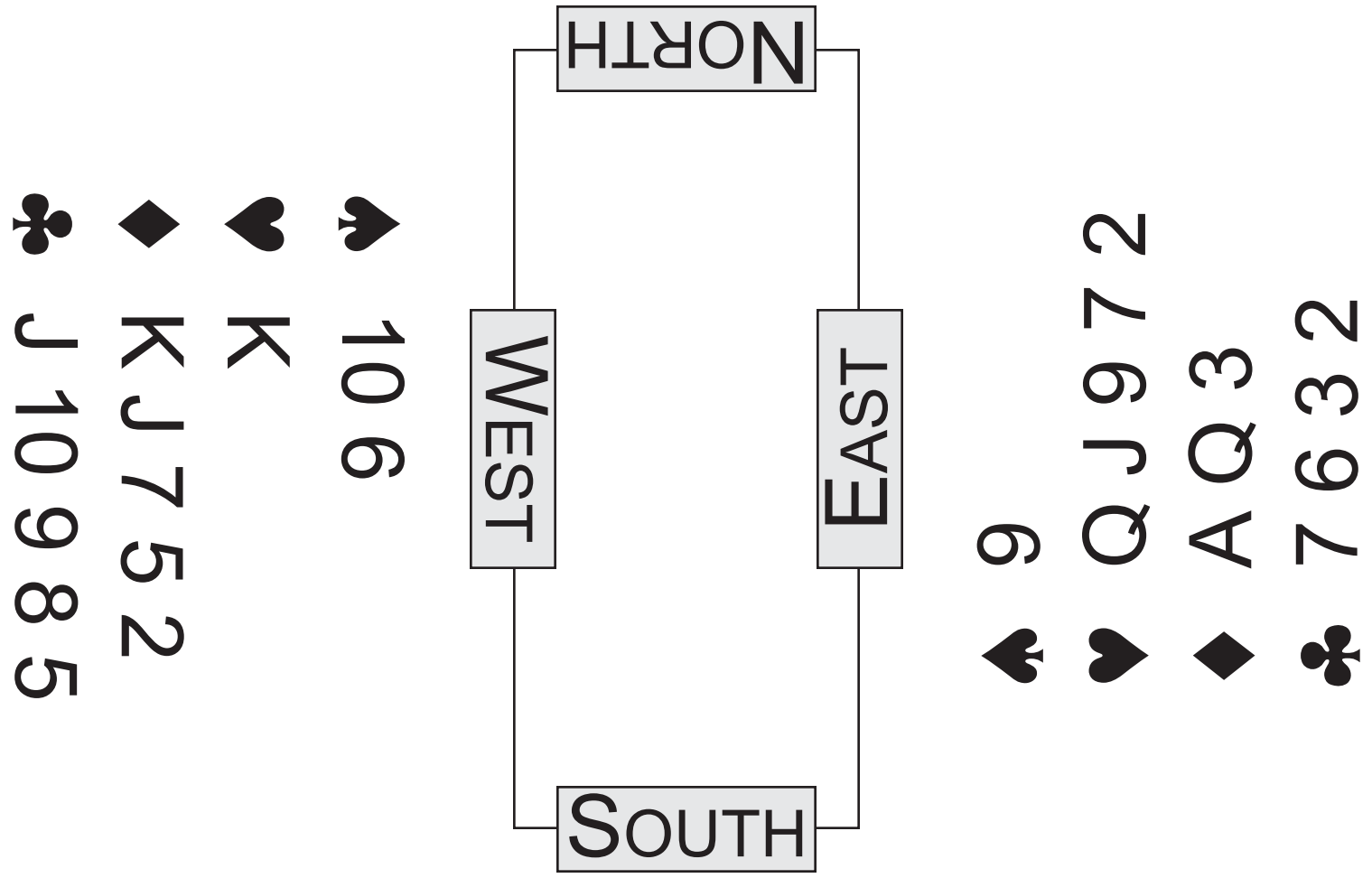

BRIDGE BASICS 1  
 DEAL: 11  
 DEALER: SOUTH

BRIDGE BASICS 1  
 DEAL: 12  
 DEALER: WEST

♣ Q J 10 3  
 ♦ 9 6 5 2  
 ♥ A 2  
 ♠ K 8 4

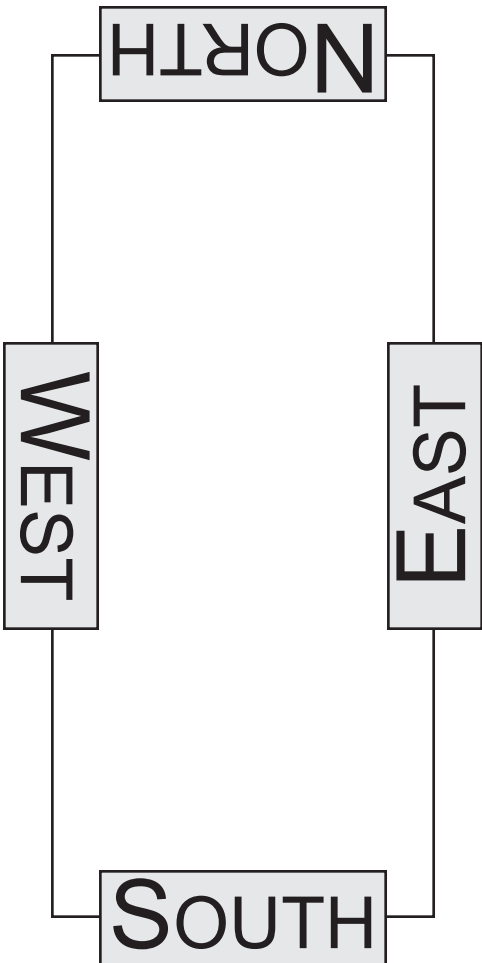

♠ Q J 10 7 3  
 ♥ K Q J 8 5  
 ♦ A 4  
 ♣ 4

♣ 9 8 6  
 ♦ K Q 7  
 ♥ 10 9 7 3  
 ♠ 6 2

♠ A 9 5  
 ♥ 9 4  
 ♦ 3 8 10 J  
 ♣ A 7 5 2

BRIDGE BASICS 1  
 DEAL: 12  
 DEALER: WEST

BRIDGE BASICS 1  
 DEAL: 13  
 DEALER: NORTH

♣ A Q  
 ♦ Q 9 8 2  
 ♥ K J 6 3  
 ♠ J 6 5

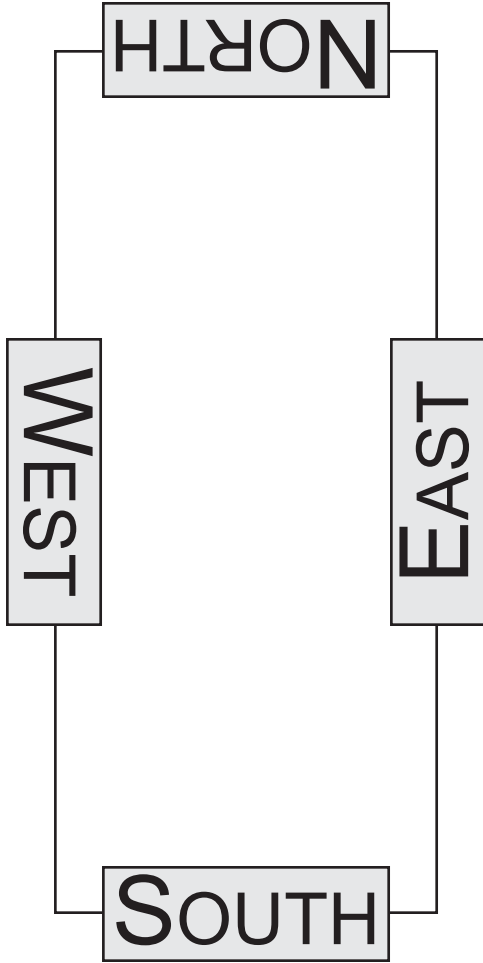

♠ K Q 7 3  
 ♥ 10 7 2  
 ♦ 6 3  
 ♣ K 10 6 5

♠ 10 8 4  
 ♥ A Q 8 5  
 ♦ A K J 5  
 ♣ 7 4

♠ A 9 2  
 ♥ 9 4  
 ♦ 10 7 4  
 ♣ J 9 8 3 2

BRIDGE BASICS 1  
 DEAL: 13  
 DEALER: NORTH

BRIDGE BASICS 1

DEAL: 14

DEALER: EAST

♣ 10 8 4 2  
 ♦ A Q 7  
 ♥ Q 7 6 2  
 ♠ 9 2

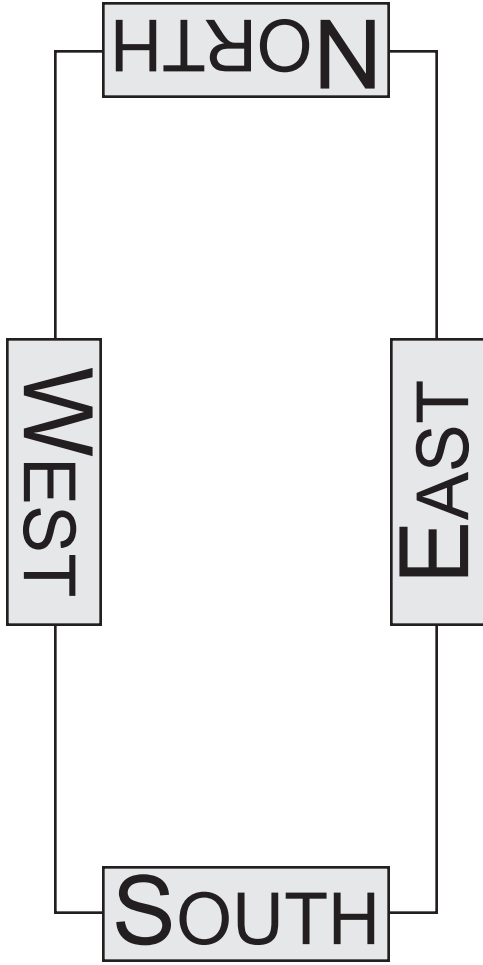

♠ K 10 7 5  
 ♥ K 10 8 4  
 ♦ J 9 5  
 ♣ A 7

♣ K Q J 6  
 ♦ 8 4 3  
 ♥ 9 3  
 ♠ A Q J 4

♣ 3 5 6  
 ♦ 2 9 10 K  
 ♥ 5 J A  
 ♠ 3 9 8

BRIDGE BASICS 1  
 DEAL: 14  
 DEALER: EAST

BRIDGE BASICS 1

DEAL: 15

DEALER: SOUTH

♣ 10 7 5  
 ♦ 9 6 3  
 ♥ A K 10 4  
 ♠ K 10 6

NORTH

WEST

SOUTH

EAST

♠ A 7 3  
 ♥ 8 7 3  
 ♦ A Q J 10 8 7  
 ♣ A

♠ J 8 5 4  
 ♥ Q 9 6  
 ♦ 5 2  
 ♣ 4 J Q K

♣ 9 8 6 3 2  
 ♦ K 4  
 ♥ J 5 2  
 ♠ Q 9 2

BRIDGE BASICS 1  
 DEAL: 15  
 DEALER: SOUTH

BRIDGE BASICS 1  
 DEAL: 16  
 DEALER: WEST

♣ A K J  
 ♦ A 10 6  
 ♠ A 8 5 2  
 ♥ Q J 3

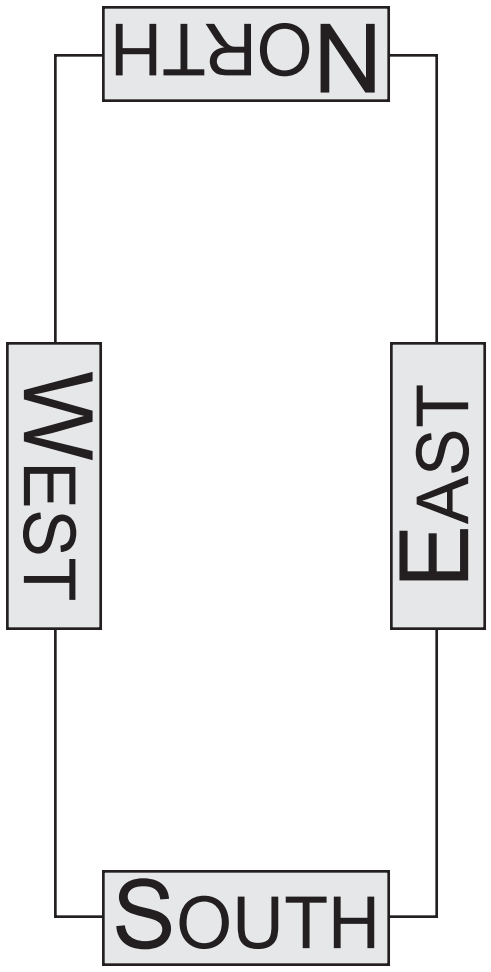

♥ 10 9 7 2  
 ♠ Q 10 9  
 ♦ Q 7  
 ♣ Q 10 9 3

♣ 6 5  
 ♦ K J 8 5 3  
 ♥ K 7 6 3  
 ♠ 6 4

♠ A K 8 5  
 ♥ J 4  
 ♦ 6 4 2  
 ♣ 7 9 4 2

BRIDGE BASICS 1  
 DEAL: 16  
 DEALER: WEST